



Operator's Manual

Serial Number Range

GS-2669RT
GS-3369RT
GS-4069RT

from GS6911-101

AUS
Australia

with
Maintenance
Information

First Edition
Third Printing
Part No. 230496

Important

Read, understand and obey these safety rules and operating instructions before operating this machine. Only trained and authorized personnel shall be permitted to operate this machine. This manual should be considered a permanent part of your machine and should remain with the machine at all times. If you have any questions, contact us.

Contact Us:

Internet: www.genielift.com

E-mail: awp.techpub@terex.com

Contents

Introduction	1
Symbol and Hazard Pictorials Definitions	3
Personal Safety	5
Work Area Safety	6
Legend	13
Controls	14
Inspections	19
Operating Instructions	32
Transport and Lifting Instructions	38
Maintenance	41
Specifications	44

Copyright © 2011 by Terex Corporation

First Edition: Third Printing, January 2012

Genie is a registered trademark of Terex South Dakota, Inc. in the U.S.A. and many other countries. "GS" is a trademark of Terex South Dakota, Inc.

These machines comply with
AS 1418.10



Introduction

Owners, Users and Operators:

Thank you for choosing our machine for your application. Our number one priority is user safety, which is best achieved by our joint efforts. We feel that you make a major contribution to safety if you, as the equipment users and operators:

- 1 **Comply** with employer, job site and governmental rules.
- 2 **Read, understand and follow** the instructions in this and other manuals supplied with this machine.
- 3 **Use good safe work practices** in a commonsense way.
- 4 **Only have trained/certified operators**, directed by informed and knowledgeable supervision, running the machine.



Danger

Failure to obey the instructions and safety rules in this manual will result in death or serious injury.

Do Not Operate Unless:

- You learn and practice the principles of safe machine operation contained in this operator's manual.
 - 1 **Avoid hazardous situations.**
 - Know and understand the safety rules before going on to the next section.**
 - 2 Always perform a pre-operation inspection.
 - 3 Always perform function tests prior to use.
 - 4 Inspect the workplace.
 - 5 Only use the machine as it was intended.
- You read, understand and obey the manufacturer's instructions and safety rules—safety and operator's manuals and machine decals.
- You read, understand and obey employer's safety rules and worksite regulations.
- You read, understand and obey all applicable governmental regulations.
- You are properly trained to safely operate the machine.

Introduction

Hazard Classification

Decals on this machine use symbols, color coding and signal words to identify the following:



Safety alert symbol—used to alert you to potential personal injury hazards. Obey all safety messages that follow this symbol to avoid possible injury or death.

▲ DANGER

Indicates a hazardous situation which, if not avoided, will result in death or serious injury.

▲ WARNING

Indicates a hazardous situation which, if not avoided, could result in death or serious injury.

▲ CAUTION

Indicates a hazardous situation which, if not avoided, could result in minor or moderate injury.

NOTICE

Indicates a property damage message.







Intended Use

This machine is intended to be used only to lift personnel, along with their tools and materials to an aerial work site.













Safety Sign Maintenance

Replace any missing or damaged safety signs. Keep operator safety in mind at all times. Use mild soap and water to clean safety signs. Do not use solvent-based cleaners because they may damage the safety sign material.

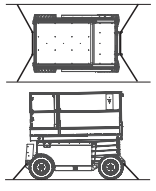
Symbol and Hazard Pictorials Definitions

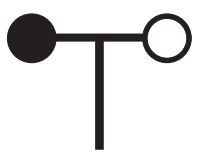
				
Read the operator's manual	Read the service manual	Crush hazard	Crush hazard	Collision hazard
				
Tip-over hazard	Tip-over hazard	Tip-over hazard	Tip-over hazard	Electrocution hazard
				
Electrocution hazard	Explosion hazard	Fire hazard	Burn hazard	Skin injection hazard
				
Engage safety arm	Keep away from moving parts	Keep clear of outriggers and tires	Move machine to level ground	Close chassis tray
				
Lower the platform	Do not set up where it cannot be leveled with outriggers	Maintain required clearance	Only trained maintenance personnel should access compartments	Use a piece of cardboard or paper to search for leaks

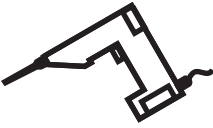
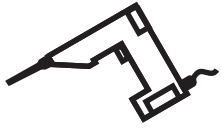
Symbol and Hazard Pictorials Definitions

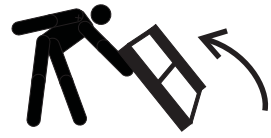
 <p>Chock the wheels</p>	 <p>Release brakes</p>	 <p>Tiedown</p>	 <p>Lanyard attachment point</p>	 <p>No smoking</p>
 <p>Wheel load</p>	 <p>Transport diagram</p>	 <p>Side force</p>	 <p>Wind speed</p>	 <p>Outrigger load</p>
 <p>Voltage rating for power to platform</p>	 <p>Pressure rating for air line to platform</p>	 <p>Maximum capacity</p>	 <p>Crushing hazard</p>	
 <p>Hold rail while lowering</p>				

Personal Safety

Personal Fall Protection

Personal fall protection equipment (PFPE) is not required when operating this machine. If PFPE is required by job site or employer rules, the following shall apply:

All PFPE must comply with applicable governmental regulations and must be inspected and used in accordance with the manufacturer's instructions.

Work Area Safety

⚠ Electrocutation Hazards

This machine is not electrically insulated and will not provide protection from contact with or proximity to electrical current.



Obey all local and governmental regulations regarding required clearance from electrical power lines. At a minimum, the required clearance contained in the chart below must be followed.

Line Voltage	Required Clearance
0 to 50KV	3.05 m
50 to 200KV	4.60 m
200 to 350KV	6.10 m
350 to 500KV	7.62 m
500 to 750KV	10.67 m
750 to 1000KV	13.72 m

Allow for platform movement, electrical line sway or sag, and beware of strong or gusty winds.



Keep away from the machine if it contacts energized power lines. Personnel on the ground or in the platform must not touch or operate the machine until energized power lines are shut off.

Do not operate the machine during lightning or storms.

Do not use the machine as a ground for welding.

⚠ Tip-over Hazards

Occupants, equipment and materials shall not exceed the maximum platform capacity or the maximum platform capacity of the platform extension.

Maximum capacity – GS-2669RT

Platform retracted	680 kg
Platform extended	680 kg
Maximum occupants	4



680 kg



136 kg

544 kg

Maximum capacity – GS-3369RT

Platform retracted	454 kg
Platform extended	454 kg
Maximum occupants	Indoor – 4 Outdoor – 2



454 kg



136 kg

318 kg

Maximum capacity – GS-4069RT

Platform retracted	363 kg
Platform extended	363 kg
Maximum occupants	Indoor – 3 Outdoor – 2



363 kg



136 kg

227 kg

Work Area Safety



Do not raise the platform unless the machine is on a firm, level surface.



Do not operate the machine in strong or gusty winds. Do not increase the surface area of the platform or the load. Increasing the area exposed to the wind will decrease machine stability.



Use extreme care and slow speeds while driving the machine in the stowed position across uneven terrain, debris, unstable or slippery surfaces and near holes and drop-offs.

Do not depend on the tilt alarm as a level indicator. The tilt alarm sounds on the chassis only when the machine is on a severe slope.

If the tilt alarm sounds:

Lower the platform. Move the machine to a firm, level surface. If the tilt alarm sounds when the platform is raised, use extreme caution to lower the platform.

Do not alter or disable the limit switches.

Do not drive over 0.48 km/h with the platform raised.

Outdoor Use: Do not raise the platform when wind speeds may exceed 12.5 m/s. If wind speeds exceed 12.5 m/s when the platform is raised, lower the platform and do not continue to operate the machine.

Indoor Use: When raising the platform, follow ratings for allowable side force and number of occupants on the next page.

Do not use the platform controls to free a platform that is caught, snagged or otherwise prevented from normal motion by an adjacent structure. All personnel must be removed from the platform before attempting to free the platform using the ground controls.

Do not drive the machine on or near uneven terrain, unstable surfaces or other hazardous conditions with the platform raised.

Do not use the machine as a crane.

Do not push the machine or other objects with the platform.

Do not contact adjacent structures with the platform.

Do not tie the platform to adjacent structures.

Do not place loads outside the platform perimeter.

Work Area Safety



Do not push off or pull toward any object outside of the platform.



Do not place ladders or scaffolds in the platform or against any part of this machine.

Maximum allowable manual force

GS-2669RT

Indoor use only – 4 person	400 N
Outdoor use – 4 person	400 N

GS-3369RT

Indoor use only – 4 person	400 N
Outdoor use – 2 person	400 N

GS-4069RT

Indoor use only – 3 person	400 N
Outdoor use – 2 person	400 N

Do not alter or disable machine components that in any way affect safety and stability.

Do not replace items critical to machine stability with items of different weight or specification.

Do not modify or alter an aerial work platform without prior written permission from the manufacturer. Mounting attachments for holding tools or other materials onto the platform, toeboards or guard rail system can increase the weight in the platform and the surface area of the platform or the load.



Do not place or attach fixed or overhanging loads to any part of this machine.

Do not transport tools and materials unless they are evenly distributed and can be safely handled by person(s) in the platform.

Do not use the machine on a moving or mobile surface or vehicle.

Be sure all tires are in good condition, castle nuts are properly tightened and cotter pins are properly installed.

▲ Operation on Slopes Hazards

Do not drive the machine on a slope that exceeds the slope and side slope rating of the machine. Slope rating applies to machines in the stowed position.

Maximum slope rating, stowed position

GS-2669RT	40% (22°)
GS-3369RT	35% (19°)
GS-4069RT	35% (19°)

Maximum side slope rating, stowed position

GS-2669RT	40% (22°)
GS-3369RT	35% (19°)
GS-4069RT	35% (19°)

Note: Slope rating is subject to ground conditions and adequate traction.

Work Area Safety

▲ Fall Hazards

The guard rail system provides fall protection. If occupant(s) of the platform are required to wear personal fall protection equipment (PFPE) due to job site or employer rules, PFPE and its use shall be in accordance with the PFPE manufacturer's instructions and applicable governmental requirements. Use approved lanyard attachment point provided.



Do not sit, stand or climb on the platform guard rails. Maintain a firm footing on the platform floor at all times.



Do not climb down from the platform when raised.

Keep the platform floor clear of debris.

Close the entry gate before operating.

Do not operate the machine unless the guard rails are properly installed and the entry is secured for operation.

Do not enter or exit the platform unless the machine is in the stowed position.

▲ Collision Hazards

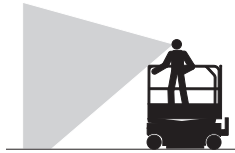

Be aware of limited sight distance and blind spots when driving or operating.

Be aware of extended platform position when moving the machine.

The machine must be on a level surface or secured before releasing the brakes.

Operators must comply with employer, job site and governmental rules regarding use of personal protective equipment.



Check the work area for overhead obstructions or other possible hazards.



Be aware of crushing hazards when grasping the platform guard rail.

Observe and use color-coded direction arrows on the platform controls and the platform decal plate for drive and steer functions.

Work Area Safety



Do not lower the platform unless the area below is clear of personnel and obstructions.



Limit travel speed according to the condition of the ground surface, congestion, slope, location of personnel, and any other factors which may cause collision.

Do not operate a machine in the path of any crane or moving overhead machinery unless the controls of the crane have been locked out and/or precautions have been taken to prevent any potential collision.

No stunt driving or horseplay while operating a machine.

▲ Bodily Injury Hazard

Always operate the machine in a well-ventilated area to avoid carbon monoxide poisoning.

Do not operate the machine with a hydraulic oil or air leak. An air leak or hydraulic leak can penetrate and/or burn skin.

Improper contact with components under any cover will cause serious injury. Only trained maintenance personnel should access compartments. Access by the operator is only advised when performing a pre-operation inspection. All compartments must remain closed and secured during operation.

▲ Component Damage Hazards

Do not use any battery or charger greater than 12V to jump-start the engine.

Do not use the machine as a ground for welding.

Work Area Safety

▲ Explosion and Fire Hazards

Do not start the engine if you smell or detect liquid petroleum gas (LPG), gasoline, diesel fuel or other explosive substances.

Do not refuel the machine with the engine running.

Refuel the machine and charge the battery only in an open, well-ventilated area away from sparks, flames and lighted tobacco.

Do not operate the machine in hazardous locations or locations where potentially flammable or explosive gases or particles may be present.

Do not spray ether into engines equipped with glow plugs.

▲ Damaged Machine Hazards

Do not use a damaged or malfunctioning machine.

Conduct a thorough pre-operation inspection of the machine and test all functions before each work shift. Immediately tag and remove from service a damaged or malfunctioning machine.

Be sure all maintenance has been performed as specified in this manual and the appropriate Genie service manual.

Be sure all decals are in place and legible.

Be sure the operator's, safety and responsibilities manuals are complete, legible and in the storage container located on the platform.

▲ Crushing Hazard

Keep hands and limbs out of scissors.

Use common sense and planning when operating the machine with the controller from the ground. Maintain safe distances between the operator, the machine and fixed objects.

Maintain a firm grasp on the platform rail when pulling the rail pins. Do not allow the platform guard rails to fall.

▲ Outrigger Safety

Tip-over Hazards

Do not lower the outriggers unless the machine is on a firm surface. Avoid drop-offs, holes, unstable or slippery surfaces and other possible hazardous conditions.

Do not raise the platform unless the machine is level. Do not set the machine up on a surface where it cannot be leveled using only the outriggers.

Do not raise the platform unless all four outriggers are properly lowered, the footpads are in firm contact with the ground and the machine is level.

Do not adjust the outriggers while the platform is raised.

Do not drive while the outriggers are lowered.

Work Area Safety

▲ Battery Safety

Burn Hazards



Batteries contain acid. Always wear protective clothing and eye wear when working with batteries.

Avoid spilling or contacting battery acid. Neutralize battery acid spills with baking soda and water.

Do not expose the batteries or the charger to water or rain during charging.

Explosion Hazards

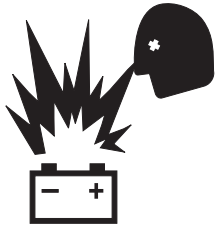

Keep sparks, flames and lighted tobacco away from batteries. Batteries emit explosive gas.

The battery tray should remain open during the entire charging cycle.



Do not contact the battery terminals or the cable clamps with tools that may cause sparks.



Component Damage Hazard

Do not use any battery charger greater than 24V to charge the batteries.

Legend

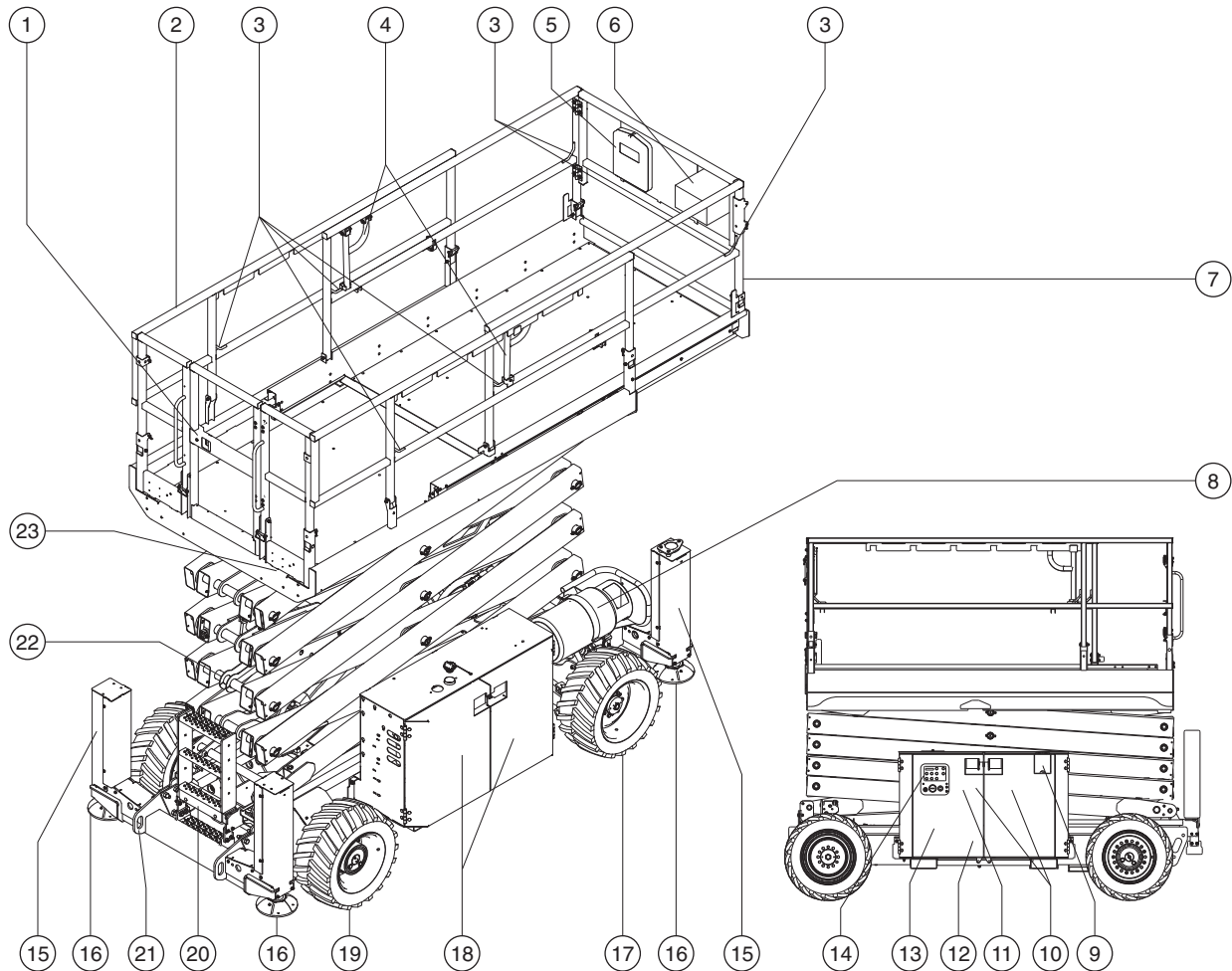

- | | | |
|----------------------------------|--|-----------------------|
| 1 Platform entry gate | 11 Hydraulic tank (behind cover) | 18 Engine side covers |
| 2 Platform guard rails | 12 Tilt alarm (behind cover) | 19 Non-steer tire |
| 3 Lanyard anchorage point | 13 Hydraulic oil level indicator (behind cover) | 20 Entry ladder |
| 4 Platform extension lock handle | 14 Ground controls with LCD readout screen | 21 Transport tie-down |
| 5 Manual storage container | 15 Outrigger housing (if equipped with outriggers) | 22 Safety arm |
| 6 Platform controls | 16 Outrigger footpad (if equipped with outriggers) | 23 GFCI outlet |
| 7 Platform extension | 17 Steer tire | |
| 8 LPG tank | | |
| 9 Fuel tank | | |
| 10 Ground controls side covers | | |



Controls

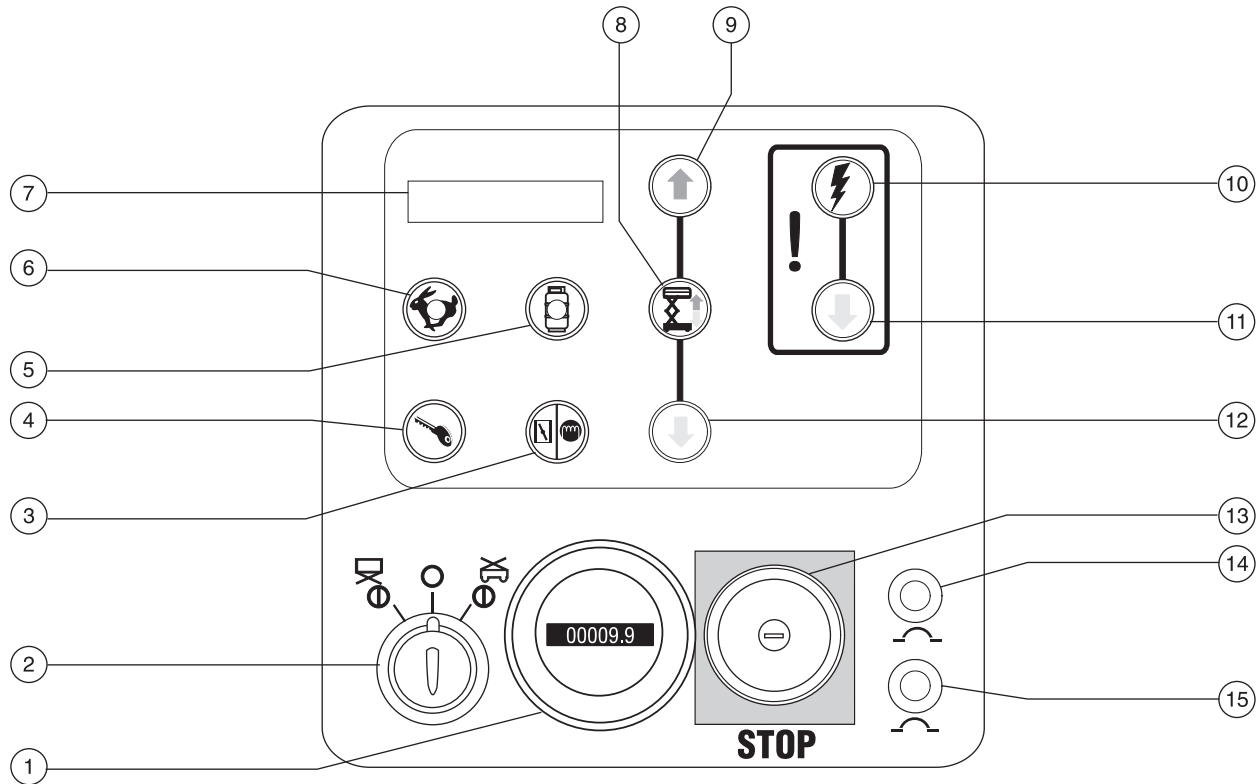

Ground Control Panel

- | | |
|--|--|
| 1 Hour meter | 8 Lift function enable button |
| 2 Key switch for platform/off/ground selection | 9 Platform up button |
| 3 Gasoline/LPG models: Choke button
Diesel models: Glow plug button | 10 Emergency lowering function enable button |
| 4 Engine start button | 11 Emergency lowering down button |
| 5 Gasoline/LPG models: LPG select button with indicator light | 12 Platform down button |
| 6 Engine idle select button with indicator light | 13 Red Emergency Stop button |
| 7 LCD readout screen | 14 20A circuit breaker for controls circuit |
| | 15 15A breaker for controls circuit |

Controls

Ground Control Panel

- | | |
|--|---|
| <p>1 Hour meter
The hour meter displays the number of hours the machine has operated.</p> <p>2 Key switch for platform/off/ground selection
Turn the key switch to the platform position and the platform controls will operate. Turn the key switch to the off position and the machine will be off. Turn the key switch to the ground position and the ground controls will operate.</p> <p>3 Gasoline/LPG models: Choke button
Press this button to activate the choke.

Diesel models: Glow plug button
Press this button to activate the glow plugs.</p> <p>4 Engine start button
Press this button to start the engine.</p> <p>5 Gasoline/LPG models: LPG select button with indicator light
Press this button to select fuel. Light on indicates that LPG is selected. Light off indicates gasoline is selected.</p> <p>6 Engine idle select button with indicator light
Press this button to select the engine idle setting. Light on indicates high idle is selected. Light off indicates low idle is selected.</p> | <p>7 LCD readout screen</p> <p>8 Lift function enable button
Press this button to activate the lift function.</p> <p>9 Platform up button
Press this button and the platform will raise.</p> <p>10 Emergency lowering function enable button
Press this button to activate the emergency lowering function.</p> <p>11 Emergency lowering down button
Press this button to activate the emergency lowering down function.</p> <p>12 Platform down button
Press this button and the platform will lower.</p> <p>13 Red Emergency Stop button
Push in the red Emergency Stop button to the off position to stop all functions. Pull out the red Emergency Stop button to the on position to operate the machine.</p> <p>14 20A circuit breaker for controls circuit</p> <p>15 15A breaker for controls circuit</p> |
|--|---|

Controls

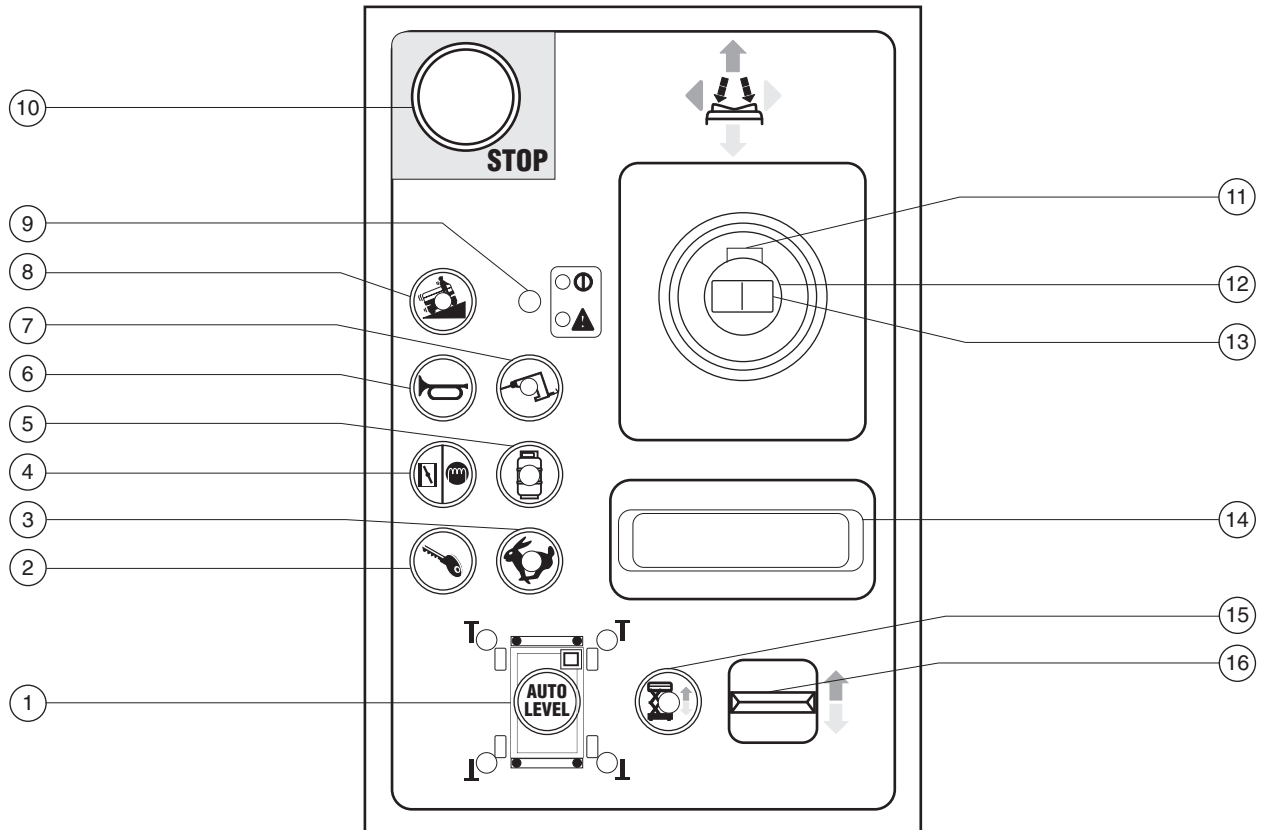

Platform Control Panel

- | | | | |
|---|---|----|--|
| 1 | Outrigger auto level button | 9 | Green power light/Red error indicator light |
| 2 | Engine start button | 10 | Red Emergency Stop button |
| 3 | Engine idle select button with indicator light | 11 | Function enable switch |
| 4 | Gasoline/LPG models: Choke button
Diesel models: Glow plug button | 12 | Proportional control handle for drive function |
| 5 | Gasoline/LPG models: LPG select button with indicator light | 13 | Thumb rocker switch for steer function |
| 6 | Horn button | 14 | Wrist rest |
| 7 | Generator select button with indicator light | 15 | Lift function enable button with indicator light |
| 8 | Machine on incline button with indicator light:
Low speed operation for inclines | 16 | Proportional rocker switch for outrigger
up/down and platform up/down |

Controls

Platform Control Panel

- 1 Outrigger auto level button
Press this button to activate the auto level function.
- 2 Engine start button
Press this button to start the engine.
- 3 Engine idle select button with indicator light
Press this button to select the engine idle setting. Light on indicates high idle is selected. Light off indicates low idle is selected.
- 4 Gasoline/LPG models: Choke button
Press this button to aid in starting the engine in cold conditions.

Diesel models: Glow plug button
Press this button to aid in starting the engine in cold conditions.
- 5 Gasoline/LPG models: LPG select button with indicator light
Press this button to select LPG.
- 6 Horn button
Press this button and the horn will sound. Release the button and the horn will stop.
- 7 Generator select button with indicator light
Press this button to turn the generator on. Indicator light will be on. Press the button again to turn the generator off.
- 8 Machine on incline button with indicator light: Low speed operation for inclines

Press this button to select low speed operation for inclines.
- 9 Green power light/Red error indicator light

Green power light is on when Red Emergency Stop button is pulled out to the on position.

If red error indicator light is on, push in and pull out the Red Emergency Stop button to set the system. If the light stays red, tag and remove the machine from service.
- 10 Red Emergency Stop button

Push in the red Emergency Stop button to the off position to stop all functions and turn the engine off. Pull out the red Emergency Stop button to the on position to operate the machine.
- 11 Function enable switch

Press and hold the function enable switch to enable the drive function.
- 12 Proportional control handle for drive function

Move the control handle in the direction indicated by the blue arrow on the control panel and the machine will move in the direction that the blue arrow points. Move the control handle in the direction indicated by the yellow arrow on the control panel and the machine will move in the direction that the yellow arrow points.

Controls

13 Thumb rocker switch for steer function

Press the left side of the thumb rocker and the machine will steer to the left.

Press the right side of the thumb rocker and the machine will steer to the right.

14 Wrist rest

15 Lift function enable button with indicator light

Press this button to enable the lift function.

16 Proportional rocker switch for outrigger up/down and platform up/down

With the auto level button indicator light on, move the rocker switch up and the outriggers will raise. Move the rocker switch down and the outriggers will lower.

With the lift function enable button indicator light on, move the rocker switch up and the platform will raise. Move the rocker switch down and the platform will lower.

Inspections



Do Not Operate Unless:

- You learn and practice the principles of safe machine operation contained in this operator's manual.
 - 1 Avoid hazardous situations.
 - 2 Always perform a pre-operation inspection.**

Know and understand the pre-operation inspection before going on to the next section.
 - 3 Always perform function tests prior to use.
 - 4 Inspect the workplace.
 - 5 Only use the machine as it was intended.

Pre-operation Inspection Fundamentals

It is the responsibility of the operator to perform a pre-operation inspection and routine maintenance.

The pre-operation inspection is a visual inspection performed by the operator prior to each work shift. The inspection is designed to discover if anything is apparently wrong with a machine before the operator performs the function tests.

The pre-operation inspection also serves to determine if routine maintenance procedures are required. Only routine maintenance items specified in this manual may be performed by the operator.

Refer to the list on the next page and check each of the items.

If damage or any unauthorized variation from factory delivered condition is discovered, the machine must be tagged and removed from service.

Repairs to the machine may only be made by a qualified service technician, according to the manufacturer's specifications. After repairs are completed, the operator must perform a pre-operation inspection again before going on to the function tests.

Scheduled maintenance inspections shall be performed by qualified service technicians, according to the manufacturer's specifications and the requirements listed in the responsibilities manual.

Inspections

Pre-operation Inspection

- Be sure that the operator's, safety and responsibilities manuals are complete, legible and in the storage container located in the platform.
- Be sure that all decals are legible and in place. See Inspections section.
- Check for hydraulic oil leaks and proper oil level. Add oil if needed. See Maintenance section.
- Check for battery fluid leaks and proper fluid level. Add distilled water if needed. See Maintenance section.
- Check for engine oil leaks and proper oil level. Add oil if needed. See Maintenance section.
- Check for engine coolant leaks and proper level of coolant. Add coolant if needed. See Maintenance section.

Check the following components or areas for damage, improperly installed or missing parts and unauthorized modifications:

- Electrical components, wiring and electrical cables
- Hydraulic hoses, fittings, cylinders and manifolds
- Drive motors
- Wear pads
- Tires and wheels
- Limit switches, alarms and horn
- Alarms and beacons (if equipped)
- Nuts, bolts and other fasteners
- Brake release components

- Safety arm
- Platform extension
- Scissor pins and retaining fasteners
- Platform control joystick
- Outrigger housing and footpads (if equipped)
- Fuel and hydraulic tanks
- Engine and related components
- Platform entry gate
- Generator (if equipped)

Check entire machine for:

- Cracks in welds or structural components
- Dents or damage to machine
- Excessive rust, corrosion or oxidation
- Be sure that all structural and other critical components are present and all associated fasteners and pins are in place and properly tightened.
- Be sure side rails are installed and bolts are fastened.

Note: If the platform must be raised to inspect the machine, make sure the safety arm is in place. See Operating Instructions section.

Inspections



Do Not Operate Unless:

- ☑ You learn and practice the principles of safe machine operation contained in this operator's manual.
 - 1 Avoid hazardous situations.
 - 2 Always perform a pre-operation inspection.
 - 3 Always perform function tests prior to use.**

Know and understand the function tests before going on to the next section.

- 4 Inspect the workplace.
- 5 Only use the machine as it was intended.

Function Test Fundamentals

The function tests are designed to discover any malfunctions before the machine is put into service. The operator must follow the step-by-step instructions to test all machine functions.

A malfunctioning machine must never be used. If malfunctions are discovered, the machine must be tagged and removed from service. Repairs to the machine may only be made by a qualified service technician, according to the manufacturer's specifications.

After repairs are completed, the operator must perform a pre-operation inspection and function tests again before putting the machine into service.

Inspections

At the Ground Controls

- 1 Select a test area that is firm, level and free of obstruction.
- 2 Pull out the platform and ground red Emergency Stop button to the on position.
- 3 Turn the key switch to ground control.
- ⊙ Result: The LCD screen will come on and display system ready.

Note: In cold climates, the LCD readout screen will need to warm up before the display appears.

- 4 Start the engine. See Operating Instructions section.

Test Emergency Stop

- 5 Push in the red Emergency Stop button to the off position.
- ⊙ Result: The engine should shut off and no functions should operate.
- 6 Pull out the red Emergency Stop button to the on position and restart the engine.

Test the Up/Down Functions

The audible warnings on this machine and the standard horn all come from the same central alarm. The horn is a constant tone. The descent alarm sounds at 60 beeps per minute. The alarm that goes off when the machine is not level sounds at 180 beeps per minute.

- 7 Do not press the lift function enable button. Press and hold the platform up button.



- ⊙ Result: The platform should not raise.
- 8 Press and hold the lift function enable button. Press and hold the platform up button.
- ⊙ Result: The platform should raise.
- 9 Press and hold the lift function enable button. Press and hold the platform down button.
- ⊙ Result: The platform should lower. The descent alarm should sound while the platform is lowering.

Inspections

Test the Tilt Sensor Operation

Note: Perform this test from the ground with the platform controller. Do not stand in the platform.

- 10 Turn the key switch to platform control.
- 11 Raise the platform 2.13 m.
- 12 Open both ground controls side covers and locate the tilt sensor beside the ground control panel.
- 13 Press down one side of the tilt sensor and place the tilt sensor test tool under one of the posts
- 14 Test all ground and platform control functions.
 - ⊙ Result: The alarm at the platform controls and ground controls should sound.
 - ⊙ Result: The drive function should not work in either direction. The lift function should not work.
 - ⊙ Result: The red error indicator light on the platform will be on.
- 15 Remove the tilt sensor test tool.
- 16 Lower the platform.

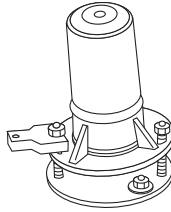

At the Platform Controls

Test Emergency Stop

- 17 Push in the platform red Emergency Stop button to the off position.
 - ⊙ Result: The engine should shut off and no functions should operate.
- 18 Pull out the red Emergency Stop button to the on position and restart the engine.
 - ⊙ Result: The indicator light should be green.



Test the Horn

- 19 Push the horn button.
 - ⊙ Result: The horn should sound.

Inspections

Test Up/Down Functions and Function Enable

- 20 Start the engine.
- 21 Activate the up/down rocker switch in the direction indicated by the blue arrow.
 - ⊙ Result: The platform should not raise.
- 22 Press and hold the lift function enable button.
 - ⊙ Result: The platform should raise.
- 23 Activate the up/down rocker switch in the direction indicated by the blue arrow.
 - ⊙ Result: The platform should raise.
- 24 Press and hold the lift function enable button.
- 25 Activate the up/down rocker switch in the direction indicated by the yellow arrow.
 - ⊙ Result: The platform should lower. The descent alarm should sound while the platform is lowering.



Test the Steering

Note: When performing the steer and drive function tests, stand in the platform facing the steer end of the machine.

- 26 Press and hold the function enable switch on the control handle.
- 27 Press the thumb rocker switch on top of the control handle in the direction indicated by the blue triangle, on the control panel.
 - ⊙ Result: The steer wheels should turn in the direction indicated by the blue triangle.
- 28 Press the thumb rocker switch in the direction indicated by the yellow triangle on the control panel.
 - ⊙ Result: The steer wheels should turn in the direction indicated by the yellow triangle.

Inspections

Test Drive and Braking

- 29 Press and hold the function enable switch on the control handle.
- 30 Slowly move the drive control handle in the direction indicated by the blue arrow on the control panel until the machine begins to move, then return the handle to the center position.
 - ⊙ Result: The machine should move in the direction that the blue arrow points on the control panel, then come to an abrupt stop.
- 31 Press and hold the function enable switch on the control handle.
- 32 Slowly move the control handle in the direction indicated by the yellow arrow on the control panel until the machine begins to move, then return the handle to the center position.
 - ⊙ Result: The machine should move in the direction that the yellow arrow points on the control panel, then come to an abrupt stop.

Note: The brakes must be able to hold the machine on any slope it is able to climb.

Test Limited Drive Speed

- 33 Press and hold the lift function enable button. Raise the platform approximately 2.28 m from the ground.
- 34 Press and hold the function enable switch on the control handle.
- 35 Slowly move the control handle to full drive position.
 - ⊙ Result: The maximum achievable drive speed with the platform raised should not exceed 13 cm per second.

If the drive speed with the platform raised exceeds 13 cm per second, immediately tag and remove the machine from service.

Test Emergency Lowering

- 36 Push and hold the lift function enable button and raise the platform approximately 60 cm.
- 37 Push in the red Emergency Stop button to shut off the engine.
- 38 Pull out the red Emergency Stop button to the on position.
- 39 Push and hold the Emergency lowering function enable button. Activate the up/down rocker switch in the direction indicated by the yellow arrow.
 - ⊙ Result: The platform should lower.

Note: The Emergency Stop button can be pushed when the test is performed.

Inspections

Test the Outrigger System (if equipped)

- 40 Push and hold the auto level button. 
- 41 Activate the up/down rocker switch in the down direction.
- ⊙ Result: The outriggers should extend and level the machine. A beep will sound when the machine is level. The indicator lights on the outrigger LED will be green.
- 42 Push and hold the auto level button.
- 43 Activate the up/down rocker switch in the up direction.
- ⊙ Result: The outriggers should retract and return to the stowed position. The indicator lights on the outrigger LED will be red.

Test the Oscillate System

Note: Perform this test from the ground with the platform controller. Do not stand in the platform.

- 44 Start the engine from the platform controls.
- 45 Select the engine idle button to indicate high idle. Light on indicates high idle. 

Test the Oscillate System (stowed position)

- 46 Drive the left steer tire up onto a 10 cm high ramp.
- ⊙ Result: All four tires should maintain firm contact with the ground.
- 47 Drive the right steer tire up onto a 10 cm high ramp.
- ⊙ Result: All four tires should maintain firm contact with the ground.

Note: Verify that there are no fault codes shown on ground control display.

Test the Oscillate System (elevated position)

- 48 Push and hold the lift function enable button and raise the platform approximately 213 cm to 274 cm.
- 49 Drive the left steer tire into a 10 cm deep hole.
- ⊙ Result: All four tires should maintain firm contact with the ground.
- 50 Drive the right steer tire into a 10 cm deep hole.
- ⊙ Result: All four tires should maintain firm contact with the ground.

Note: Verify that there are no fault codes shown on ground control display.

Inspections



Do Not Operate Unless:

- You learn and practice the principles of safe machine operation contained in this operator's manual.
 - 1 Avoid hazardous situations.
 - 2 Always perform a pre-operation inspection.
 - 3 Always perform function tests prior to use.
 - 4 Inspect the workplace.**

Know and understand the workplace inspection before going on to the next section.

 - 5 Only use the machine as it was intended.

Workplace Inspection Checklist

Be aware of and avoid the following hazardous situations:

- drop-offs or holes
- bumps, floor obstructions or debris
- sloped surfaces
- unstable or slippery surfaces
- overhead obstructions and high voltage conductors
- hazardous locations
- inadequate surface support to withstand all load forces imposed by the machine
- wind and weather conditions
- the presence of unauthorized personnel
- other possible unsafe conditions

Workplace Inspection Fundamentals

The workplace inspection helps the operator determine if the workplace is suitable for safe machine operation. It should be performed by the operator prior to moving the machine to the workplace.

It is the operator's responsibility to read and remember the workplace hazards, then watch for and avoid them while moving, setting up and operating the machine.

Inspections

Decals Inspection with Words

Determine whether the decals on your machine have words or symbols. Use the appropriate inspection to verify that all decals are legible and in place.

Below is a numerical list with quantities and descriptions.

Part No.	Decal Description	Qty
28158	Label – Unleaded	1
28159	Label – Diesel	1
28160	Label – Liquid Petroleum Gas (1 additional with extra LPG tank option)	1
28174	Label – Power to Platform, 230V	2
28175	Warning – Compartment Access	1
28176	Label – Missing Manuals	1
28235	Label – Power to Platform, 115V	2
28236	Warning – Improper Operation	1
28373	Label – Forklift Pocket	4
31060	Danger – Tip-over Hazard, Limit Switch	1
31788	Danger – Explosion/Burn Hazard	1
40434	Label – Lanyard Anchorage Point	6
43618	Label – Directional Arrows	1
44255	Danger – Crushing Hazard	4
44736	Danger – Tip-over Hazard, Tilt Alarm	1
44981	Label – Air Line to Platform	2
52475	Label – Transport Tie-down	4
52494	Caution – Crushing Hazard, Rails	1
52865	Warning – Annual Inspection Record	1
52967	Cosmetic – 4 x 4	2
72086	Label – Lifting Point	4
72186	Warning – Crushing Hazard, Outriggers	4
82366	Label – Chevron Rando	1
82418	Ground Control Panel	1
82557	Label – Platform Controls Location	1
82558	Warning – Skin Injection Hazard	2
82561	Danger – Crushing Hazard	2
82793	Instructions – Operating Instructions, Ground	1
97602	Warning – Explosion Hazard	1
97719	Label – Safety Arm	1
114202	Label – Transport Diagram	2

Part No.	Decal Description	Qty
114258	Danger – Explosion Hazard	1
114385	Danger – Electrocutation Hazard	2
114386	Danger – General Safety Rules	2
131587	Instructions – Kubota Diesel Engine Specs	1
133278	Label – Low Sulfur Fuel (diesel models)	1
139249	Instructions – Perkins Engine Specs	1
228327	Cosmetic – Genie GS-2669RT	2
228328	Cosmetic – Genie GS-3369RT	2
228329	Cosmetic – Genie GS-4069RT	2
228407	Ground Control Panel	1
229427	Label – Outrigger Load	4
229430	Instructions – Max Manual Force, 400 N, GS-2669RT, AUS	1
229431	Instructions – Max Manual Force, 400 N, GS-3369RT, AUS	1
229432	Instructions – Max Manual Force, 400 N, GS-4069RT, AUS	1
229827	Warning – Hot Surface	3
229835	Instructions – Tire Specifications, Front	2
229871	Instructions – Kubota Gas Engine Specs	1
229915	Danger – Outrigger Safety and Instructions	1

Decal inspection continued on following page.

Inspections

Additional decals for models with outriggers

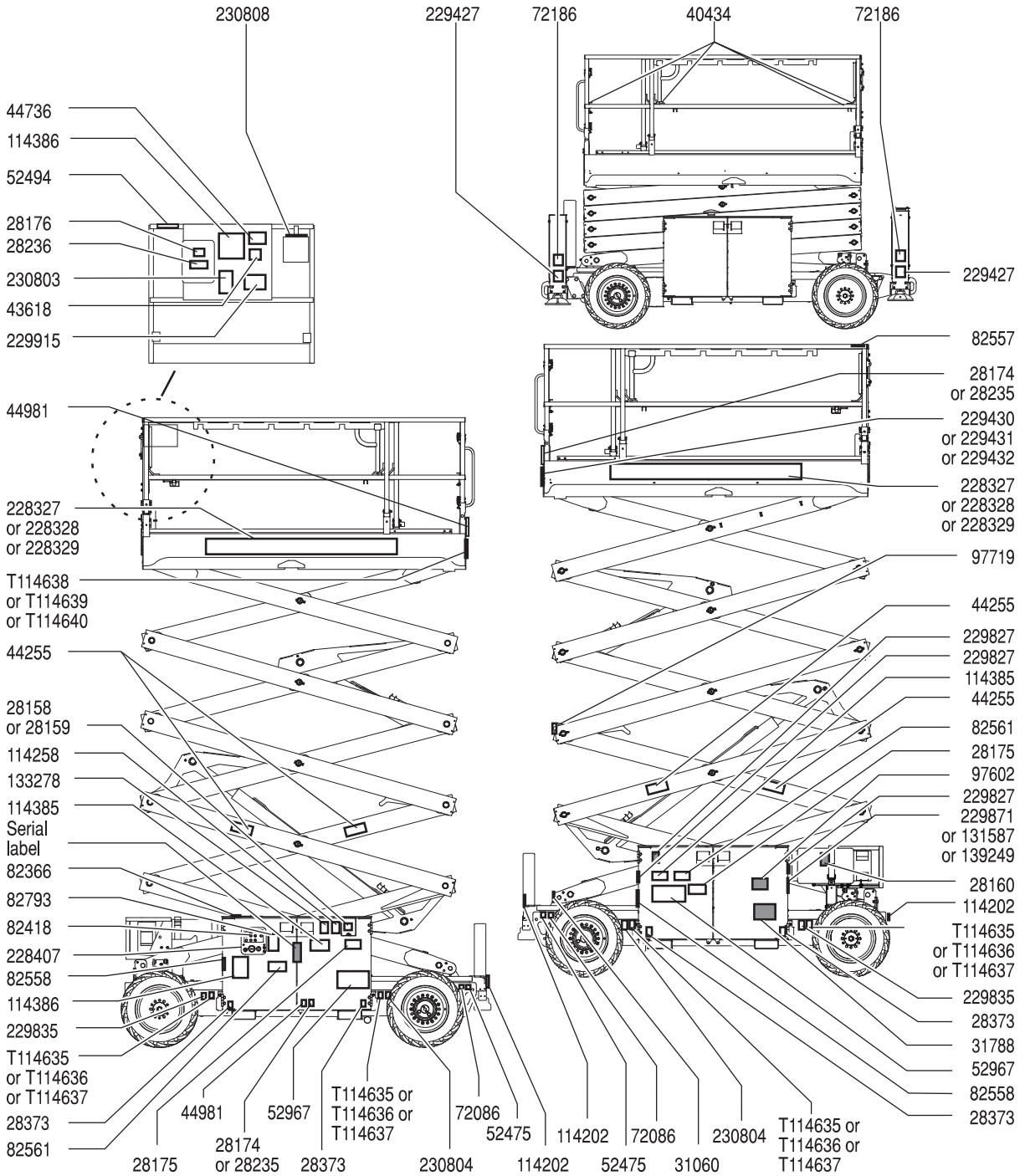

■ Shading indicates decal is hidden from view, i.e. under covers



Inspections

Decals Inspection with Words

Determine whether the decals on your machine have words or symbols. Use the appropriate inspection to verify that all decals are legible and in place.

Below is a numerical list with quantities and descriptions.

Decal inspection continued from previous page.

Part No.	Decal Description	Qty
T114638	Instructions – Max Capacity, 1500 lbs / 680 kg, GS-2669	1
T114639	Instructions – Max Capacity, 1000 lbs / 454 kg, GS-3369	1
T114640	Instructions – Max Capacity, 800 lbs / 363 kg, GS-4069	1
230803	Instructions – Operating Instructions, Platform	1
230804	Instructions – Tire Specifications, Rear	1
230808	Platform Control Panel	1
T114635	Label – Wheel Load, GS-2669RT	4
T114636	Label – Wheel Load, GS-3369RT	4
T114637	Label – Wheel Load, GS-4069RT	4

Inspections

Additional decals for models with outriggers

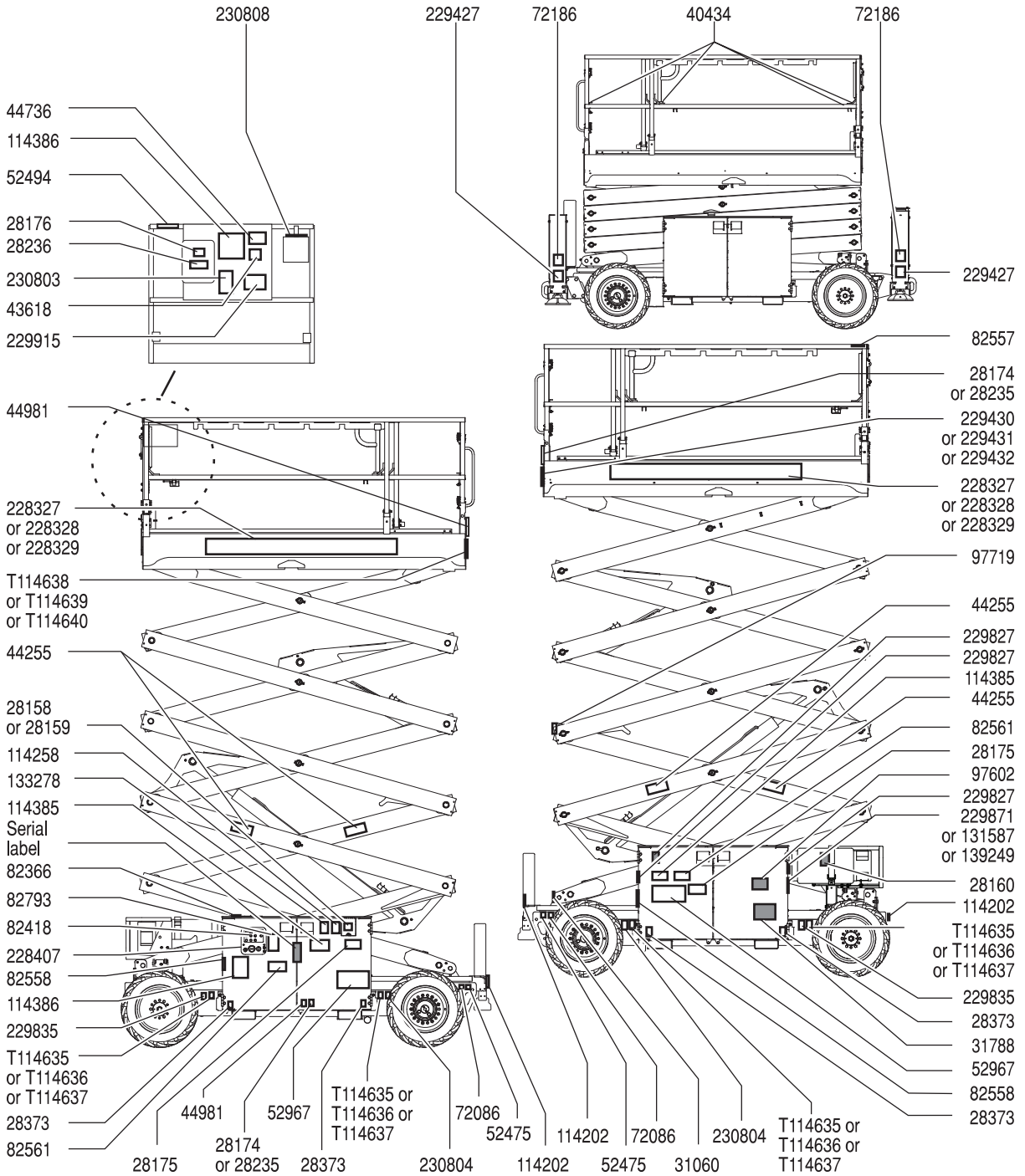

■ Shading indicates decal is hidden from view, i.e. under covers



Operating Instructions



Do Not Operate Unless:

- You learn and practice the principles of safe machine operation contained in this operator's manual.
 - 1 Avoid hazardous situations.
 - 2 Always perform a pre-operation inspection.
 - 3 Always perform function tests prior to use.
 - 4 Inspect the workplace.
 - 5 **Only use the machine as it was intended.**

Fundamentals

The Operating Instructions section provides instructions for each aspect of machine operation. It is the operator's responsibility to follow all the safety rules and instructions in the operator's, safety and responsibilities manuals.

Using the machine for anything other than lifting personnel, along with their tools and materials, to an aerial work site is unsafe and dangerous.

Only trained and authorized personnel should be permitted to operate a machine. If more than one operator is expected to use a machine at different times in the same work shift, they must all be qualified operators and are all expected to follow all safety rules and instructions in the operator's, safety and responsibilities manuals. That means every new operator should perform a pre-operation inspection, function tests, and a workplace inspection before using the machine.

Operating Instructions

Emergency Stop

Push in the red Emergency Stop button to the off position at the ground controls or the platform controls to stop all machine functions and turn the engine off.

Repair any function that operates when either red Emergency Stop button is pushed in.

Starting the Engine

- 1 At the ground controls, turn the key switch to the desired position.
- 2 Be sure both ground and platform control red Emergency Stop buttons are pulled out to the on position.

Gasoline/LPG models

- 1 Select LPG by pushing the LPG button.
- 2 Push the engine start button.

Note: In cold conditions, 20°F / -6°C and below, the machine should be started on gasoline and warmed for 2 minutes, then switched to LPG. Warm engines can be started on LPG.

Diesel models

- 1 Push the engine start button.

Note: In cold condition, 50°F / 10°C and below, push and hold the glow plug button for 5 to 10 seconds before starting the engine. Limit continuous use of the glow plug button to 20 seconds.

All models

If the engine fails to start after 15 seconds of cranking, determine the cause and repair any malfunction. Wait 60 seconds before trying to start again.

In cold conditions, 20°F / -6°C and below, warm the engine for 5 minutes before operating to prevent hydraulic system damage.

In extreme cold conditions, 0°F / -18°C and below, machines should be equipped with optional cold start kits. Attempting to start the engine when temperatures are below 0°F / -18°C may require the use of a booster battery.

Operation from Ground

- 1 Turn the key switch to ground control.
- 2 Pull out both ground and platform red Emergency Stop buttons to the on position.
- 3 Start the engine.

To Position Platform

- 1 Push and hold the lift function enable button.
- 2 Activate the up function or the down function.



Drive and steer functions are not available from the ground controls.

Engine Idle Select

Select the engine idle (rpm) by pressing the idle select button. There are two settings for engine idle:

- Indicator light off: low idle
- Indicator light on: high idle



Operating Instructions

Operation from Platform

- 1 Turn the key switch to platform control.
- 2 Pull out both ground and platform red Emergency Stop buttons to the on position.
- 3 Start the engine.

To Position Platform

- 1 Push and hold the lift function enable button.
- 2 Activate the up/down rocker switch in the desired direction.



To Steer

- 1 Press and hold the function enable switch on the control handle.
- 2 Turn the steer wheels with the thumb rocker switch located on the top of the control handle.

To Drive

- 1 Press and hold the function enable switch on the control handle.
- 2 Increase speed: Slowly move the control handle off center.

Decrease speed: Slowly move the control handle toward center.

Stop: Return the control handle to center or release the function enable switch.

Use the color-coded direction arrows on the platform controls and the drive chassis to identify the direction the machine will travel.

Machine travel speed is restricted when the platform is raised.

Drive Select Button



Machine on incline symbol: Low range operation for inclines

Indicator Light On Red



If the indicator light is on red, push in and pull out the red Emergency Stop button to reset the system.

If the light stays red, tag and remove the machine from service.

Indicator Light Flashing Red



If the indicator light is flashing red, the platform is overloaded and no functions will operate. An alarm will sound at the platform controls.

Remove weight from the platform.

Push in and pull out the red Emergency Stop button to reset the system.

If the platform is still overloaded, the light will continue to flash.

Operating Instructions

▲ Driving on a slope

Determine the slope and side slope ratings for the machine and determine the slope grade.

Maximum slope rating, stowed position:



GS-2669RT	40%	22°
GS-3369RT	35%	19°
GS-4069RT	35%	19°

Maximum side slope rating, stowed position:



GS-2669RT	40%	22°
GS-3369RT	35%	19°
GS-4069RT	35%	19°

Note: Slope rating is subject to ground conditions and adequate traction.

To determine the slope grade:

Measure the slope with a digital inclinometer OR use the following procedure.

You will need:

- carpenter's level
- straight piece of wood, at least 1 m long
- tape measure

Lay the piece of wood on the slope.

At the downhill end, lay the level on the top edge of the piece of wood and lift the end until the piece of wood is level.

While holding the piece of wood level, measure the vertical distance from the bottom of the piece of wood to the ground.

Divide the tape measure distance (rise) by the length of the piece of wood (run) and multiply by 100.

Example:

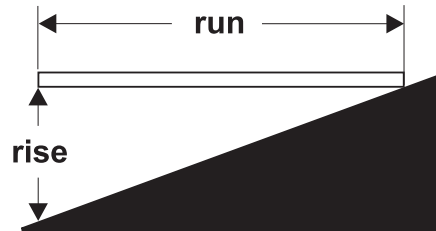

Piece of wood = 3.6 m

Run = 3.6 m

Rise = 0.3 m

$0.3 \text{ m} \div 3.6 \text{ m} = 0.083 \times 100 = 8.3\% \text{ grade}$

If the slope exceeds the maximum uphill, downhill or side slope rating, then the machine must be winched or transported up or down the slope. See Transport and Lifting section.

Operating Instructions

To Extend and Retract Platform

- 1 Lift the platform extension lock handle to the horizontal position.
- 2 Push the platform extension lock handle to extend the platform to the desired position.

Do not stand on the platform extension while trying to extend it.

- 3 Lower the platform extension lock handles and make sure the extension deck is locked.

Emergency Lowering

At the Ground Controls

Push and hold the lift function enable button and activate the down function.

In the event of a power failure, use the Emergency Lowering function enable button and the Emergency Lowering down button.

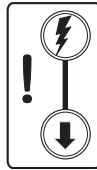

At the Platform Controls

Push and hold the lift function enable button and activate the up/down rocker switch in the down direction.

Operation from Ground with Controller

Maintain safe distances between the operator, machine and fixed objects.

Be aware of the direction the machine will travel when using the controller.

Outrigger Operation (if equipped)

- 1 Position the machine below the desired work area.

Note: The engine must be running for the outriggers to operate.

- 2 Push and hold the auto level button.



- 3 Activate the up/down rocker switch in the down direction. The outriggers will extend and level the machine. A beep will sound when the machine is level.

The indicator light on the lift function enable button will turn red when one but not all outriggers are down. All drive and lift functions are disabled.



The light turns green on the lift function enable button and on the individual outrigger buttons when all the outriggers are in firm contact with the ground.

The drive function is disabled while the outriggers are down.

Operating Instructions

Platform Overload Indicator Light



Light flashing indicates the platform is overloaded. The engine will stop and no functions will operate.

Remove weight from the platform until the light goes off and then restart the engine.

After Each Use

- 1 Select a safe parking location—firm level surface, clear of obstruction and traffic.
- 2 Lower the platform.
- 3 Turn the key switch to the off position and remove the key to secure from unauthorized use.
- 4 Chock the wheels.

Transport and Lifting Instructions



Observe and Obey:

- ☑ Genie provides this securement information as a recommendation. Drivers are solely responsible for making sure machines are properly secured and the correct trailer is selected pursuant to US Department of Transportation regulations, other localized regulations, and their company policy.
- ☑ Genie customers needing to containerize any lift or Genie product should source a qualified freight forwarder with expertise in preparing, loading and securing construction and lifting equipment for international shipment.
- ☑ Only qualified aerial lift operators should move the machine on or off the truck.
- ☑ The transport vehicle must be parked on a level surface.
- ☑ The transport vehicle must be secured to prevent rolling while the machine is being loaded.
- ☑ Be sure the vehicle capacity, loading surfaces and chains or straps are sufficient to withstand the machine weight. Genie lifts are very heavy relative to their size. See the serial label for the machine weight.
- ☑ If the slope of the transport vehicle bed exceeds the maximum slope rating, the machine must be loaded and unloaded using a winch as described in the brake release operation.

Free-wheel Configuration for Winching

Chock the wheels to prevent the machine from rolling.

4WD models: Release the wheel brakes by turning over the two rear torque hub disconnect caps. Turn needle valve on traction manifold counter-clockwise until it stops.

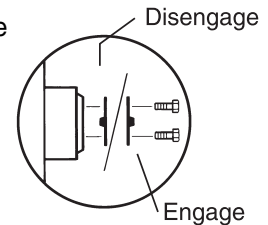

Be sure the winch line is properly secured to the drive chassis tie points and the path is clear of all obstructions.

Reverse the procedures described to re-engage the brakes.

Note: The needle valve should always remain closed during normal operation.

Transport and Lifting Instructions

Securing to Truck or Trailer for Transit

Always chock the machine wheels in preparation for transport.

Retract and secure the extension deck.

Use the tie-down points on the chassis for anchoring down to the transport surface.

Use a minimum of 2 chains or straps.

Use chains or straps of ample load capacity.

Turn the key switch to the off position and remove the key before transporting.

Inspect the entire machine for loose or unsecured items.

If the railings have been folded down, secure them with straps before transporting.

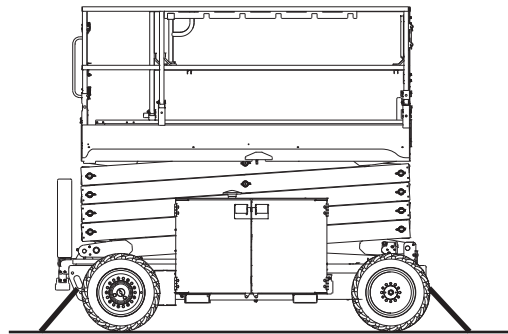
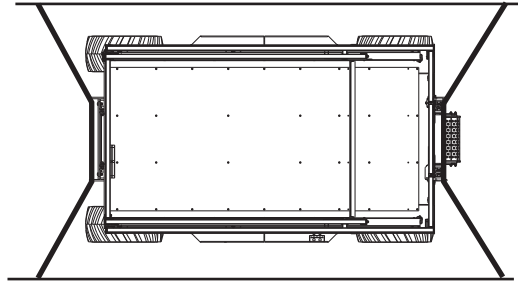

Transport and Lifting Instructions



Observe and Obey:

- ☑ Only qualified riggers should rig and lift the machine.
- ☑ Be sure the crane capacity, loading surfaces and straps or lines are sufficient to withstand the machine weight. See the serial label for the machine weight.

Lifting Instructions

Fully lower the platform. Be sure the extension deck, controls and component trays are secure. Remove all loose items on the machine.

Determine the center of gravity of your machine using the table and the picture on this page.

Attach the rigging only to the designated lifting points on the machine.

Adjust the rigging to prevent damage to the machine and to keep the machine level.

Center of gravity	X Axis	Y Axis
GS-2669RT	108.1 cm	78.5 cm
GS-3369RT	108.2 cm	79.8 cm
GS-4069RT	98.6 cm	79.0 cm

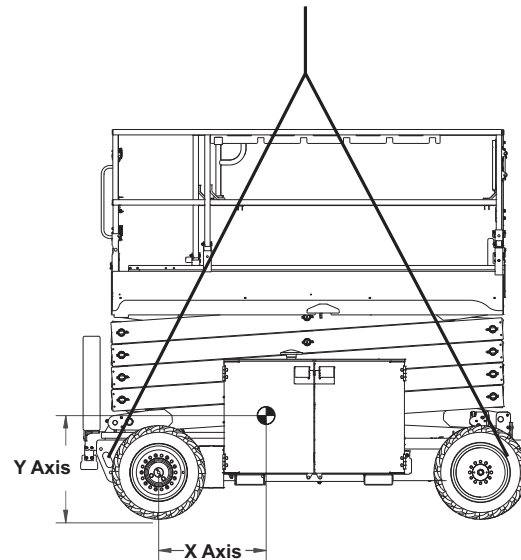

Maintenance



Observe and Obey:

- ☑ Only routine maintenance items specified in this manual shall be performed by the operator.
- ☑ Scheduled maintenance inspections shall be completed by qualified service technicians, according to the manufacturer's specifications and the requirements specified in the responsibilities manual.

Maintenance Symbols Legend

The following symbols have been used in this manual to help communicate the intent of the instructions. When one or more of the symbols appear at the beginning of a maintenance procedure, it conveys the meaning below.



Indicates that tools will be required to perform this procedure.



Indicates that new parts will be required to perform this procedure.



Indicates that a cold engine is required before performing this procedure.

Check the Engine Oil Level



Maintaining the proper engine oil level is essential to good engine performance and service life. Operating the machine with an improper oil level can damage engine components.

Note: Check the oil level with the engine off.

- 1 Check the oil level dipstick. Add oil as needed.

Kubota WG-972-E3 Engine

Oil type	SAE10W to 10W-30
----------	------------------

Kubota D-1105 Engine

Oil type	SAE10W to 10W-30
----------	------------------

Perkins 403D-11 Engine

Oil type	SAE 15W-40
----------	------------

Maintenance

Check the Hydraulic Oil Level



Maintaining the hydraulic oil at the proper level is essential to machine operation. Improper hydraulic oil levels can damage hydraulic components. Daily checks allow the inspector to identify changes in oil level that might indicate the presence of hydraulic system problems.

- 1 Be sure that the platform is in the stowed position and the engine off.
- 2 Visually inspect the sight gauge located on the side of the hydraulic oil tank.
 - ⊙ Result: The hydraulic oil level should be within the top 5 cm of the sight gauge.
- 3 Add oil as needed. Do not overfill.

Hydraulic oil specifications

Hydraulic oil type	Chevron Rando HD equivalent
--------------------	-----------------------------

Check the Batteries



Proper battery condition is essential to good machine performance and operational safety. Improper fluid levels or damaged cables and connections can result in component damage and hazardous conditions.

Note: This procedure does not need to be performed on machines with sealed or maintenance-free batteries.

- ▲ Electrocuting hazard. Contact with hot or live circuits may result in death or serious injury. Remove all rings, watches and other jewelry.
- ▲ Bodily injury hazard. Batteries contain acid. Avoid spilling or contacting battery acid. Neutralize battery acid spills with baking soda and water.

Note: Perform this test after fully charging the batteries.

- 1 Put on protective clothing and eye wear.
- 2 Be sure that the battery cable connections are tight and free of corrosion.
- 3 Be sure that the battery hold-down brackets are in place and secure.

Note: Adding terminal protectors and a corrosion preventative sealant will help eliminate the corrosion on the battery terminals and cables.

Maintenance

Check the Engine Coolant Level



Maintaining the engine coolant at the proper level is essential to engine service life. Improper coolant level will affect the engine's cooling capability and damage engine components. Daily checks will allow the inspector to identify changes in coolant level that might indicate cooling system problems.

- 1 Check the fluid level in the coolant recovery tank. Add fluid as needed.
- ▲ Bodily Injury Hazard. Fluids in the radiator are under pressure and extremely hot. Use caution when removing cap and adding fluids.

Scheduled Maintenance

Maintenance performed quarterly, annually and every two years must be completed by a person trained and qualified to perform maintenance on this machine according to the procedures found in the service manual for this machine.

Machines that have been out of service for more than three months must receive the quarterly inspection before they are put back into service.

Specifications

GS-2669RT	
Height, working maximum	9.8 m
Height, platform maximum	8 m
Height, stowed maximum, rails up	2.59 m
Height, stowed maximum, rails lowered	1.92 m
Height, guard rails	1.47 m
Width	1.75 m
Length, platform retracted	3.12 m
Length, platform retracted, models with outriggers	3.76 m
Length, platform extended	4.51 m
Length, platform extended, models with outriggers	4.81 m
Length, outside platform extended	4.32 m
Maximum load capacity	680 kg
Maximum wind speed	
Indoor	0 m/s
Outdoor	12.5 m/s
Wheelbase	2.29 m
Turning radius (outside)	4.6 m
Turning radius (inside)	2.11 m
Ground clearance	24 cm
Weight	3309 kg
(Machine weights vary with option configurations. See serial label for specific machine weight.)	
Controls	Proportional
AC outlet in platform	Standard
Platform dimensions	
Platform length x width	2.79 x 1.6 m
Platform extension length	2.67 m

Drive speeds	
Stowed maximum	5.63 km/h
Platform raised, maximum	0.48 km/h 12.2 m/90 sec
Maximum hydraulic pressure (functions)	241 bar
Tire size	26 x 12 x 380 in
Airborne noise emissions	
Sound pressure level at ground workstation	<85 dBA
Sound pressure level at platform workstation	<79 dBA
Vibration value does not exceed 2.5 m/s ²	
Maximum slope rating, stowed position	40% (22°)
Maximum side slope rating, stowed position	40% (22°)
Note: Slope rating is subject to ground conditions and adequate traction.	
Floor loading information	
Tire load, maximum	1311 kg
Outrigger load, maximum	1311 kg
Tire contact pressure	5.06 kg/cm ² 496 kPa
Outrigger contact pressure	2.59 kg/cm ² 254 kPa
Occupied floor pressure	846 kg/m ² 8.3 kPa
Note: Floor loading information is approximate and does not incorporate different option configurations. It should be used only with adequate safety factors	
Continuous improvement of our products is a Genie policy. Product specifications are subject to change without notice or obligation.GS-3369RT	

Specifications

GS-3369RT

Height, working maximum	11.9 m
Height, platform maximum	10 m
Height, stowed maximum, rails up	2.59 m
Height, stowed maximum, rails lowered	192 m
Height, guard rails	1.47 m
Width	1.75 m
Length, platform retracted	3.12 m
Length, platform retracted, models with outriggers	3.76 m
Length, platform extended	4.51 m
Length, platform extended, models with outriggers	4.81 m
Length, outside platform extended	4.32 m
Maximum load capacity	454 kg
Maximum wind speed	
Indoor	0 m/s
Outdoor	12.5 m/s
Wheelbase	2.29 m
Turning radius (outside)	4.6 m
Turning radius (inside)	2.11 m
Ground clearance	24 cm
Weight	3490 kg
(Machine weights vary with option configurations. See serial label for specific machine weight.)	
Controls	Proportional
AC outlet in platform	Standard
Platform dimensions	
Platform length x width	2.79 x 1.6 m
Platform extension length	2.67 m

Drive speeds

Stowed maximum	5.63 km/h
Platform raised, maximum	0.48 km/h 12.2 m/90 sec
Maximum hydraulic pressure (functions)	241 bar
Tire size	26 x 12 x 380 in

Airborne noise emissions

Sound pressure level at ground workstation	<85 dBA
Sound pressure level at platform workstation	<79 dBA

Vibration value does not exceed 2.5 m/s²

Maximum slope rating, stowed position 35% (19°)

Maximum side slope rating, stowed position 35% (19°)

Note: Slope rating is subject to ground conditions and adequate traction.

Floor loading information

Tire load, maximum	1387 kg
Outrigger load, maximum	1387 kg
Tire contact pressure	5.35 kg/cm ² 524 kPa
Outrigger contact pressure	2.74 kg/cm ² 268 kPa
Occupied floor pressure	838 kg/m ² 8.22 kPa

Note: Floor loading information is approximate and does not incorporate different option configurations. It should be used only with adequate safety factors

Continuous improvement of our products is a Genie policy. Product specifications are subject to change without notice or obligation.

Specifications

GS-4069RT

Height, working maximum	14 m
Height, platform maximum	12.3 m
Height, stowed maximum, rails up	2.74 m
Height, stowed maximum, rails lowered	2.08 m
Height, guard rails	1.47 m
Width	1.75 m
Length, platform retracted	3.12 m
Length, platform retracted, models with outriggers	3.76 m
Length, platform extended	4.51 m
Length, platform extended, models with outriggers	4.81 m
Length, outside platform extended	4.32 m
Maximum load capacity	363 kg
Maximum wind speed	
Indoor	0 m/s
Outdoor	12.5 m/s
Wheelbase	2.29 m
Turning radius (outside)	4.6 m
Turning radius (inside)	2.11 m
Ground clearance	24 cm
Weight	4681 kg
(Machine weights vary with option configurations. See serial label for specific machine weight.)	
Controls	Proportional
AC outlet in platform	Standard
Platform dimensions	
Platform length x width	2.79 x 1.6 m
Platform extension length	2.67 m

Drive speeds

Stowed maximum	5.63 km/h
Platform raised, maximum	0.48 km/h 12.2 m/90 sec

Maximum hydraulic pressure (functions)	241 bar
--	---------

Tire size	26 x 12 x 380 in
-----------	------------------

Airborne noise emissions

Sound pressure level at ground workstation	<85 dBA
--	---------

Sound pressure level at platform workstation	<78 dBA
--	---------

Vibration value does not exceed 2.5 m/s²

Maximum slope rating, stowed position	35% (19°)
--	-----------

Maximum side slope rating, stowed position	35% (19°)
---	-----------

Note: Slope rating is subject to ground conditions and adequate traction.

Floor loading information

Tire load, maximum	1731 kg
--------------------	---------

Outrigger load, maximum	1731 kg
-------------------------	---------

Tire contact pressure	6.68 kg/cm ² 654 kPa
-----------------------	------------------------------------

Outrigger contact pressure	3.42 kg/cm ² 335 kPa
----------------------------	------------------------------------

Occupied floor pressure	1045 kg/m ² 10.25 kPa
-------------------------	-------------------------------------

Note: Floor loading information is approximate and does not incorporate different option configurations. It should be used only with adequate safety factors

Continuous improvement of our products is a Genie policy. Product specifications are subject to change without notice or obligation.

www.genielift.com

Distributed By: